



**GRE**

GRADUATE RECORD EXAMINATIONS®

Large Print Figure Supplement for

Math Review

Chapter 3: Geometry



Copyright © 2010 by Educational Testing Service. All rights reserved. ETS, the ETS logo, GRADUATE RECORD EXAMINATIONS, and GRE are registered trademarks of Educational Testing Service (ETS) in the United States and other countries.

Geometry Figure 1

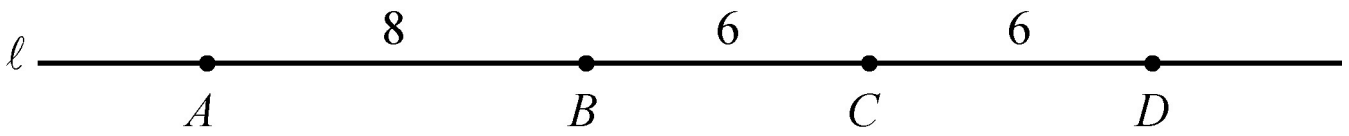

Geometry Figure 2

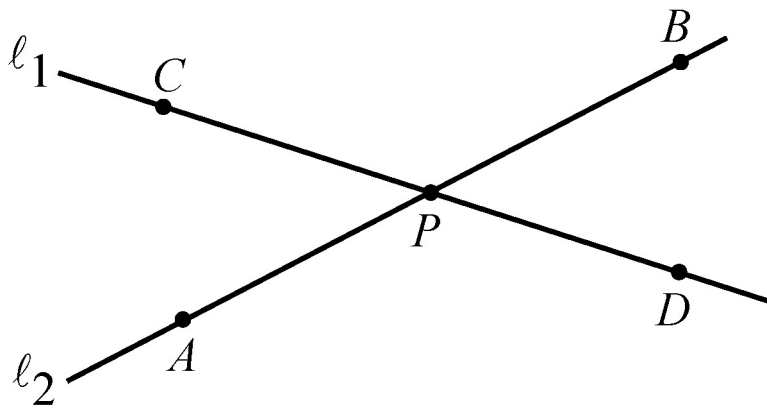

Geometry Figure 3

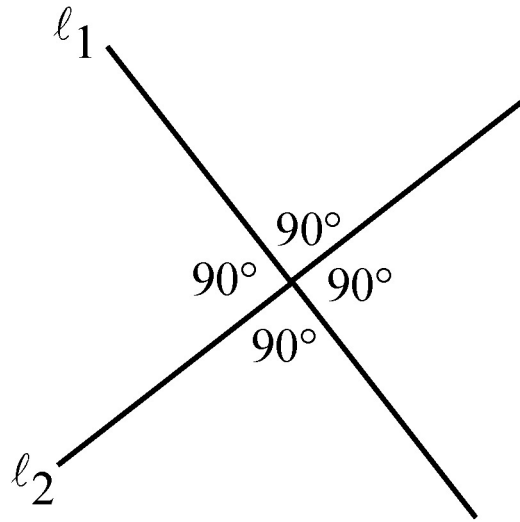

Geometry Figure 4

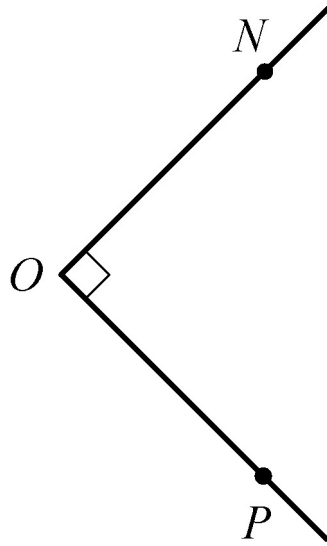

Geometry Figure 5

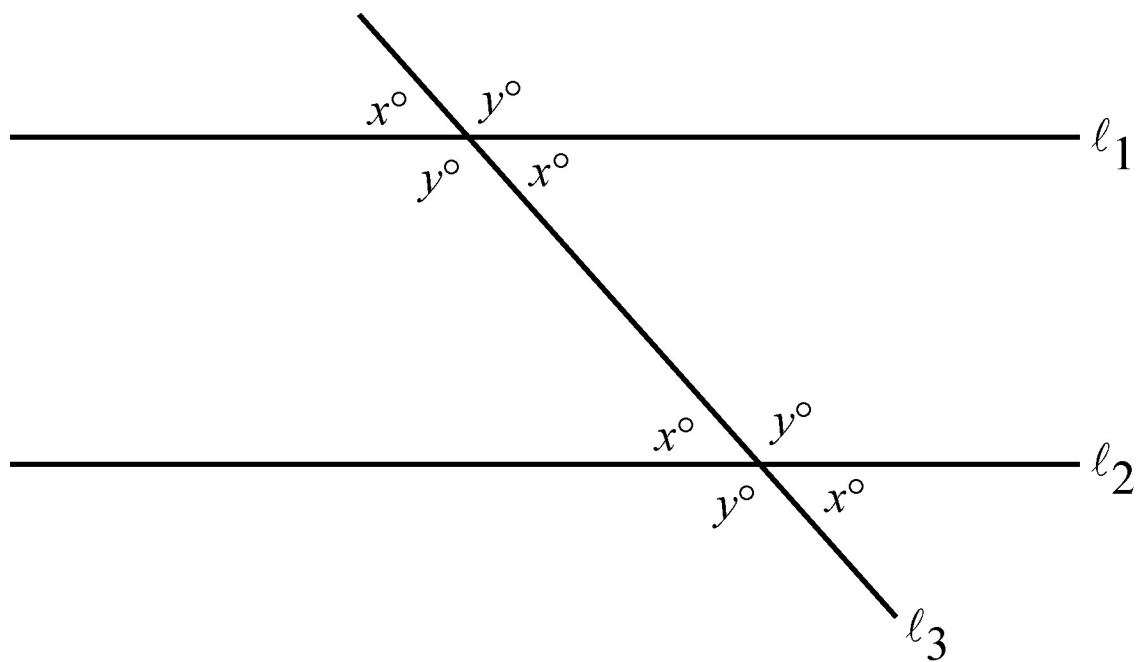

Geometry Figure 6

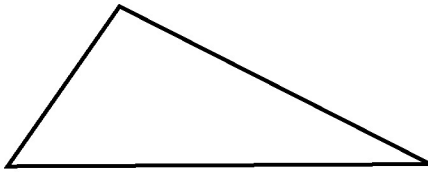

Triangle  
(3 sides)

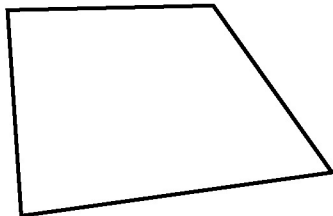

Quadrilateral  
(4 sides)

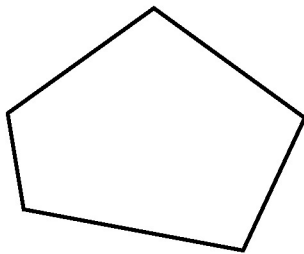

Pentagon  
(5 sides)

Geometry Figure 7

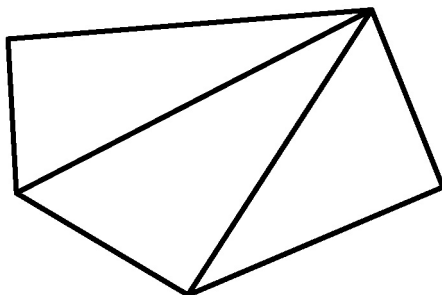
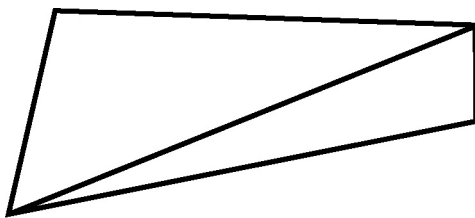



Geometry Figure 8

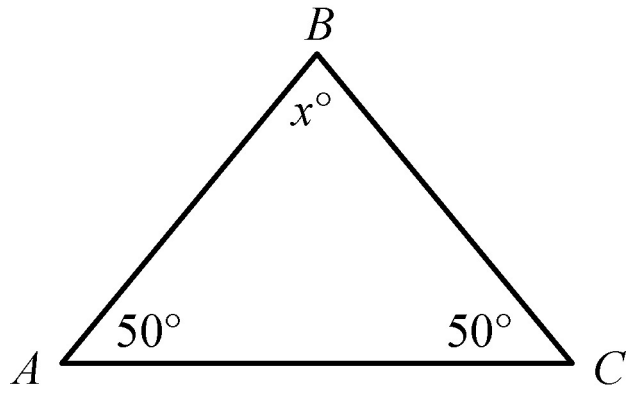

Geometry Figure 9

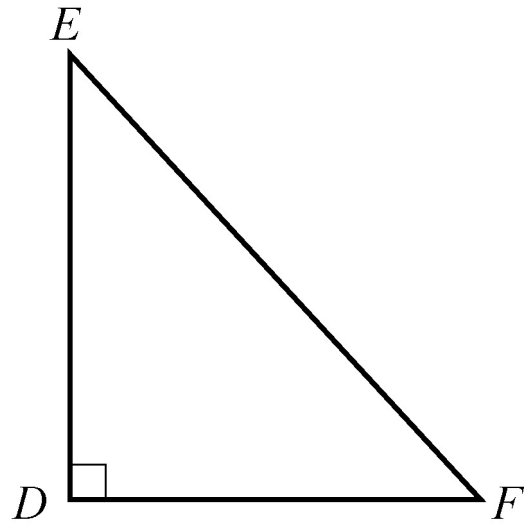

Geometry Figure 10

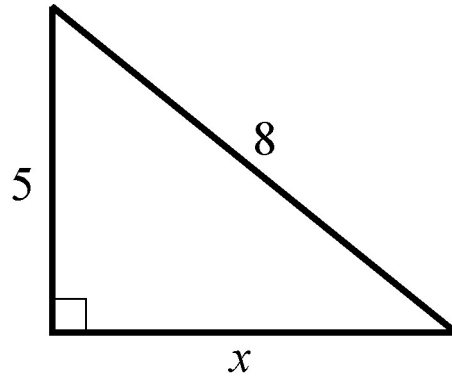

Geometry Figure 11

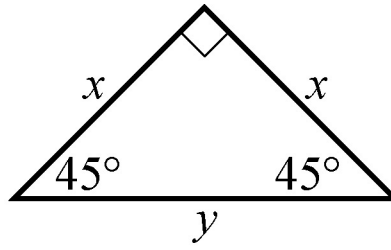

Geometry Figure 12

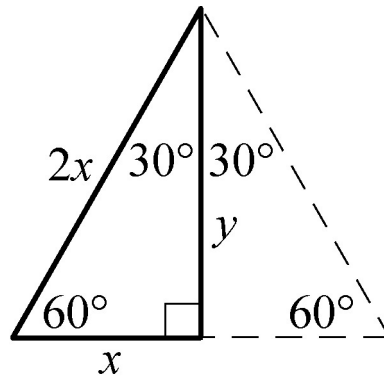

Geometry Figure 13

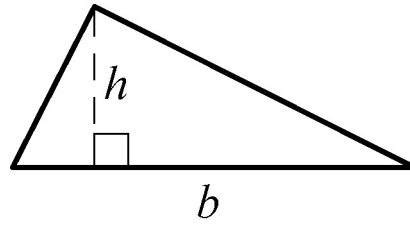

Geometry Figure 14

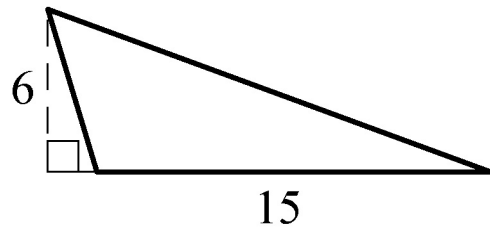
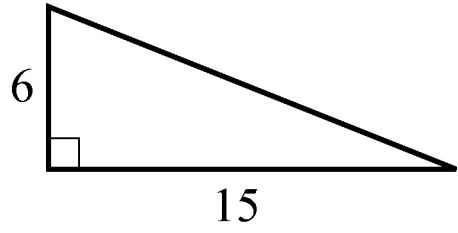
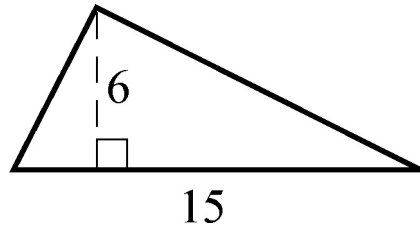

Geometry Figure 15

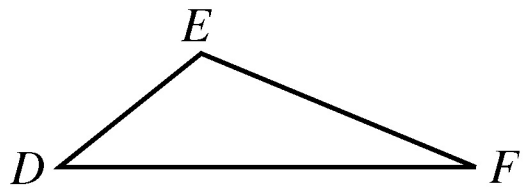
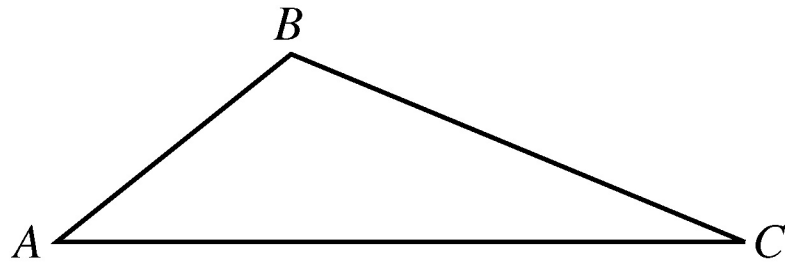



Geometry Figure 16

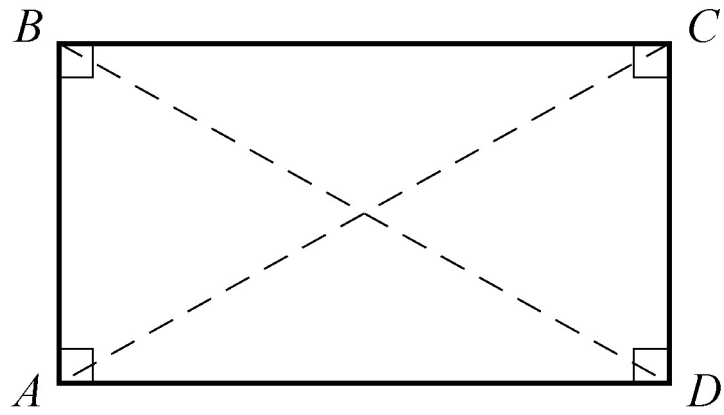

Geometry Figure 17

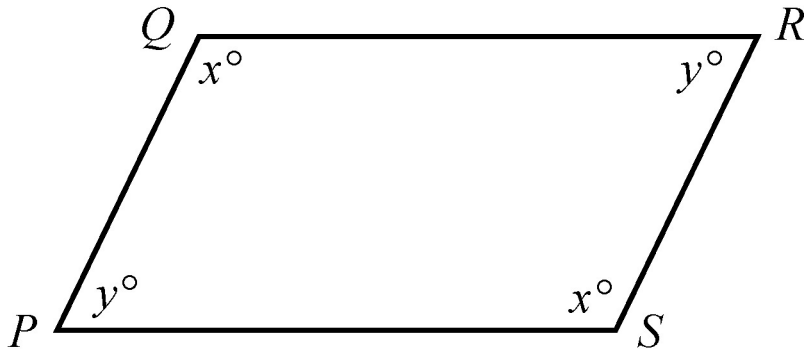

Geometry Figure 18

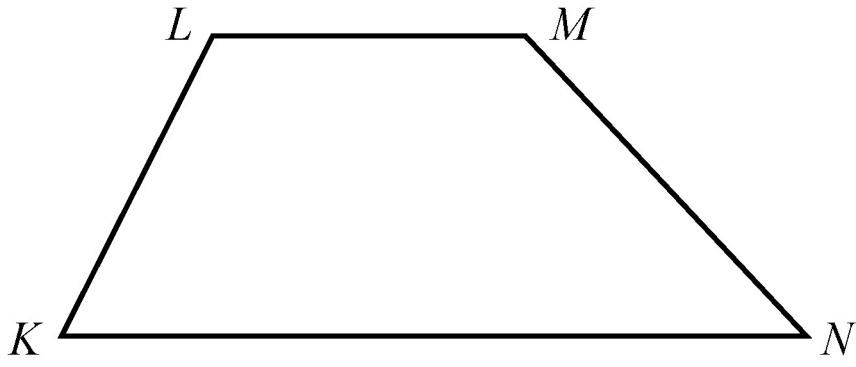

Geometry Figure 19

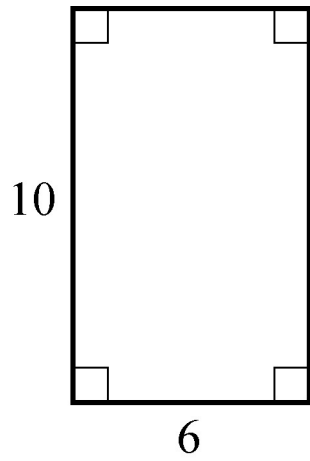

$$A = (6)(10) = 60$$

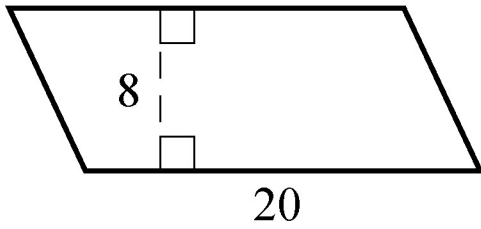

$$A = (20)(8) = 160$$

Geometry Figure 20

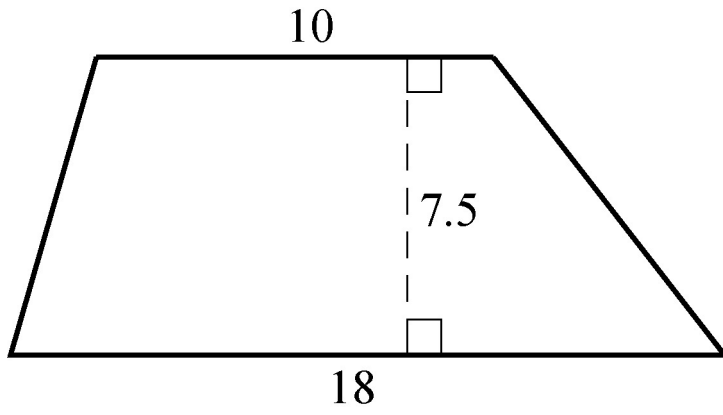

Geometry Figure 21

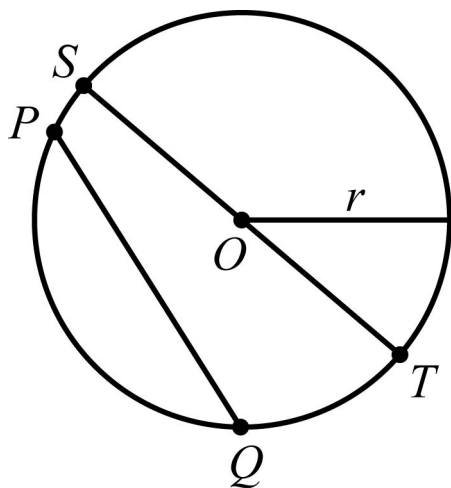

Geometry Figure 22

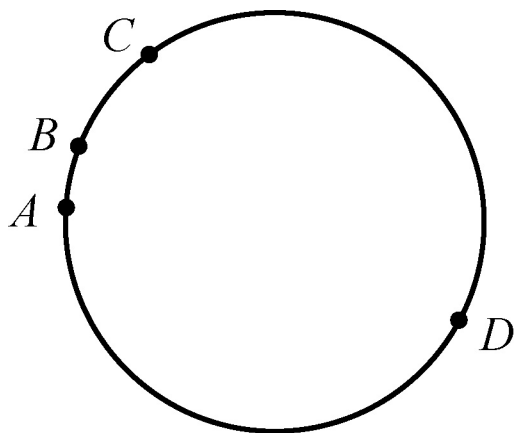

Geometry Figure 23

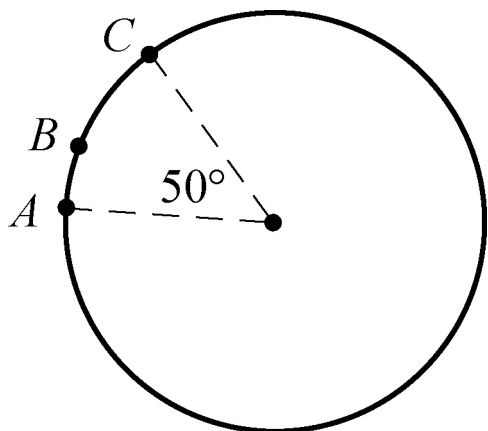



Geometry Figure 24

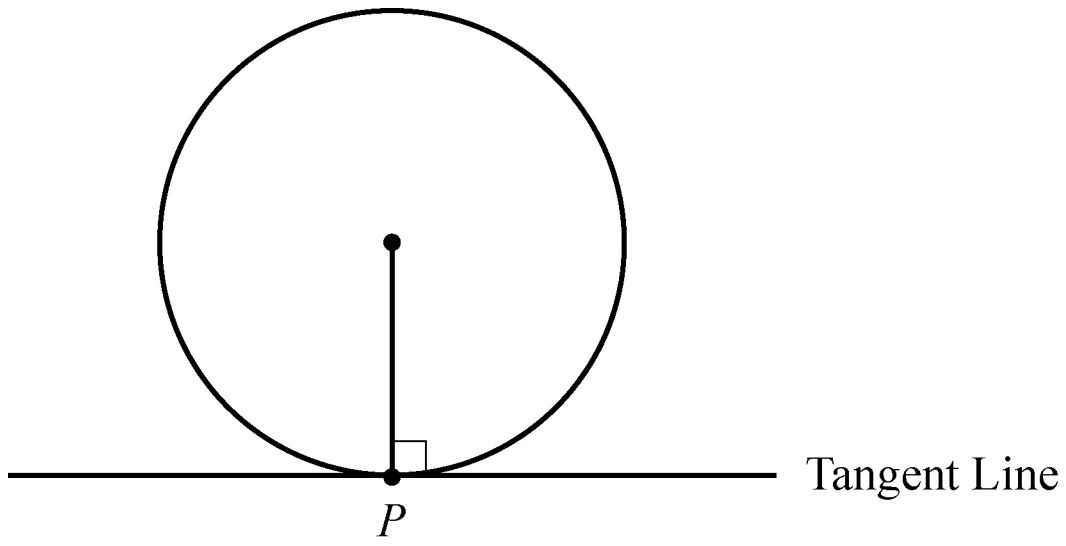

Geometry Figure 25

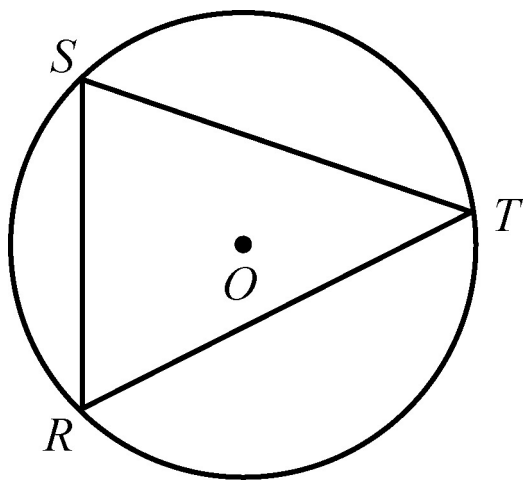

Geometry Figure 26

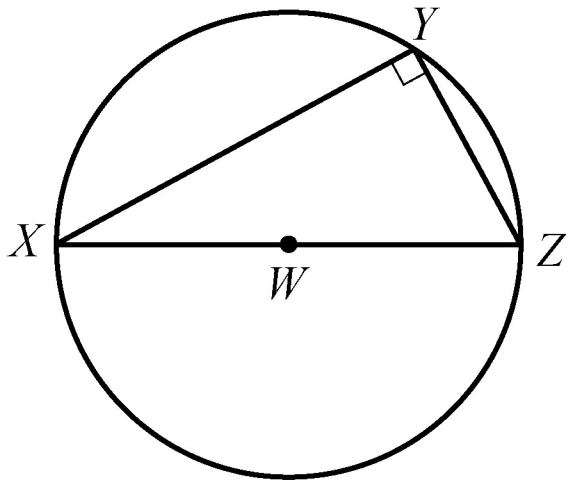

Geometry Figure 27

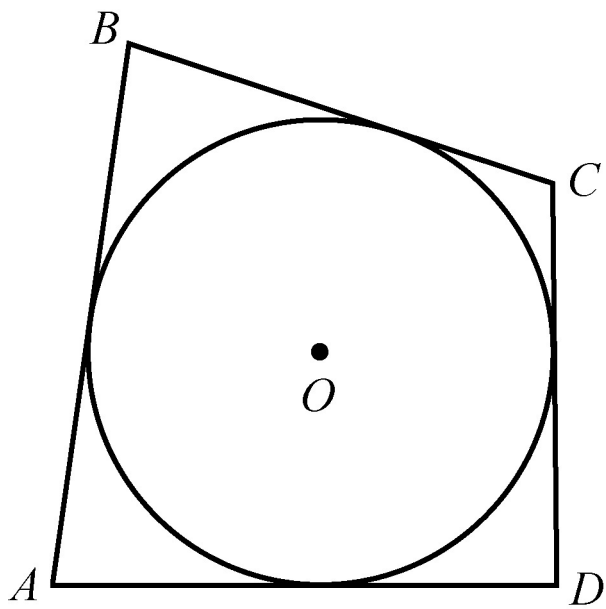

Geometry Figure 28

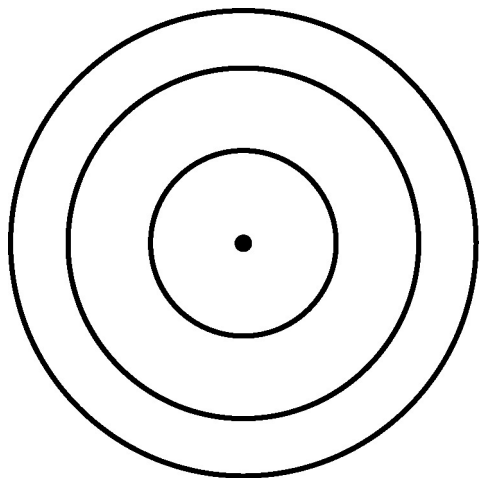

Geometry Figure 29

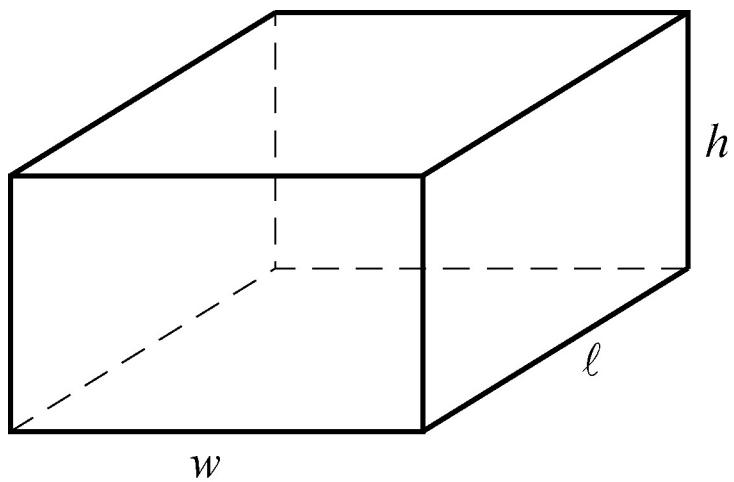

Geometry Figure 30

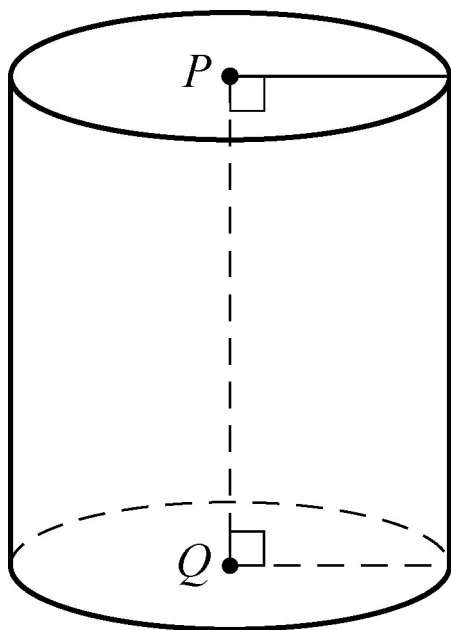

Geometry Figure 31

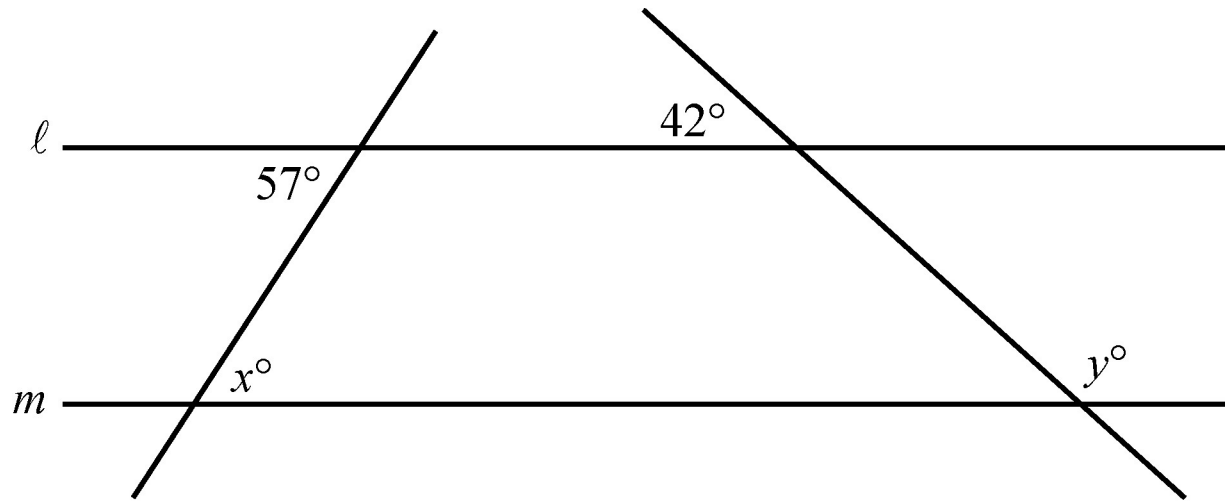



Geometry Figure 32

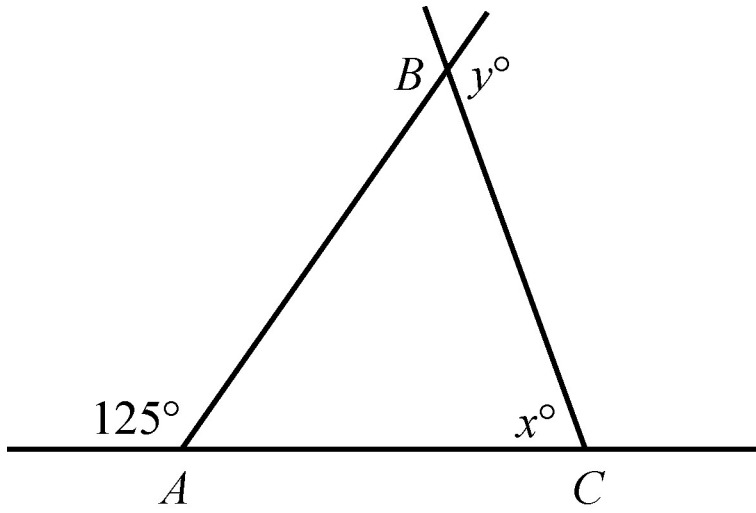

Geometry Figure 33

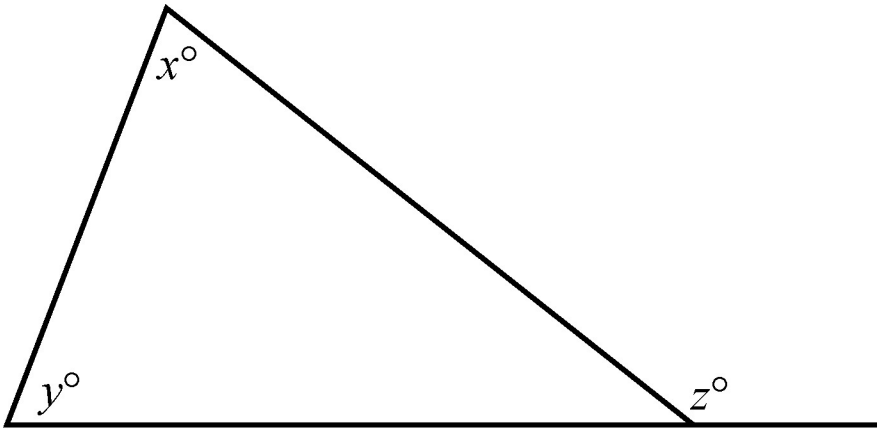

Geometry Figure 34

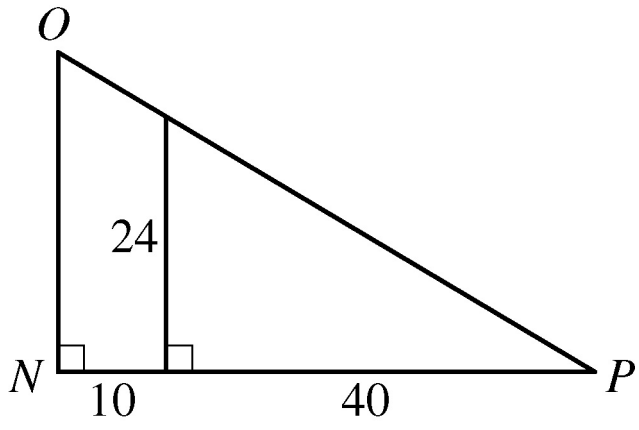

Geometry Figure 35

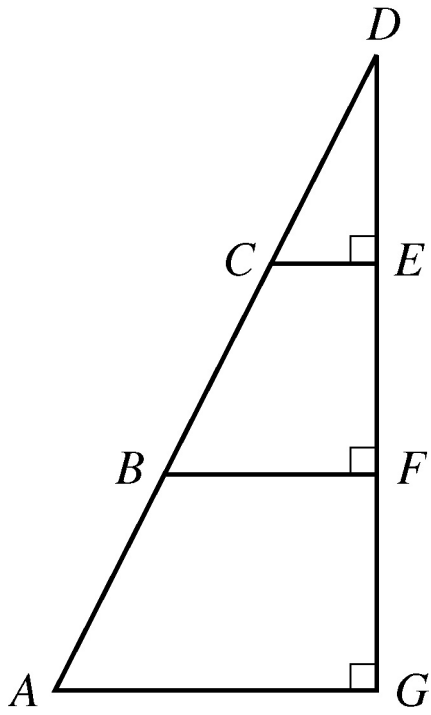

Geometry Figure 36

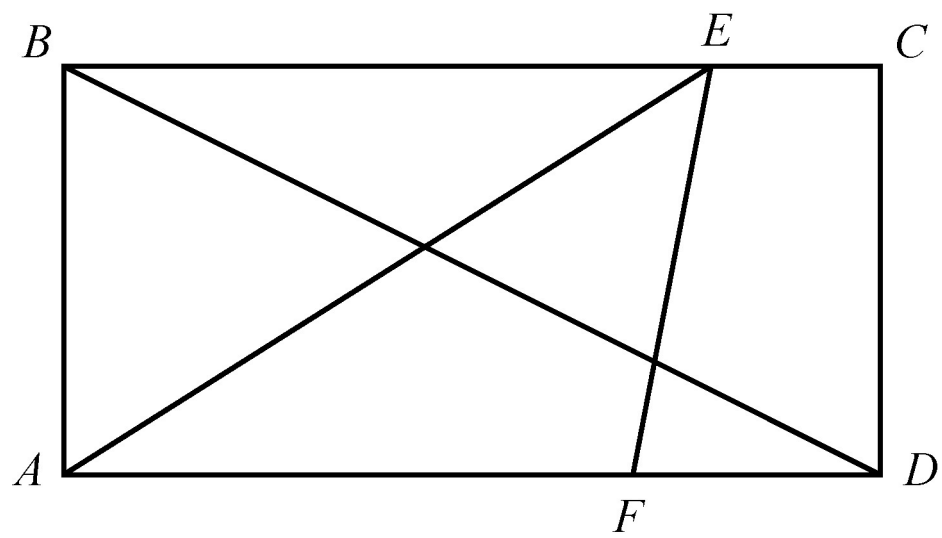

Geometry Figure 37

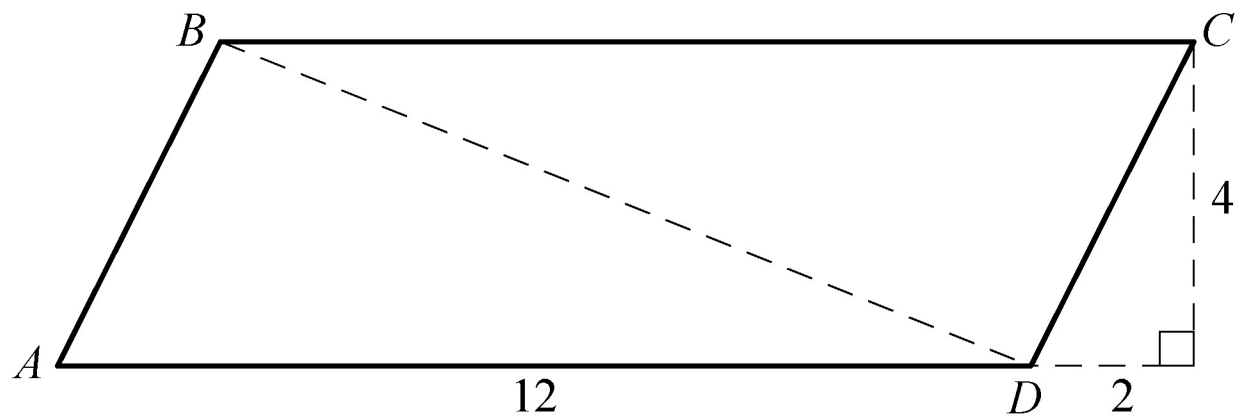

Geometry Figure 38

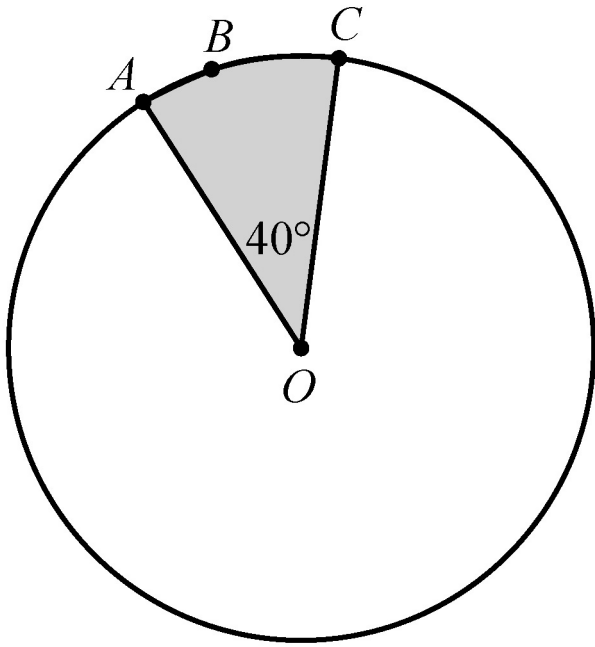

Geometry Figure 39

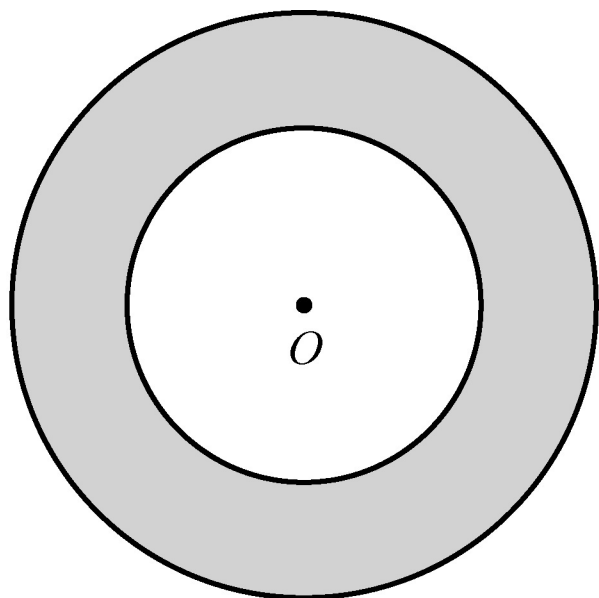



Geometry Figure 40

